

Article number: 0102216

Description: Retaining ring J390 DIN472
Spring steel

Measures

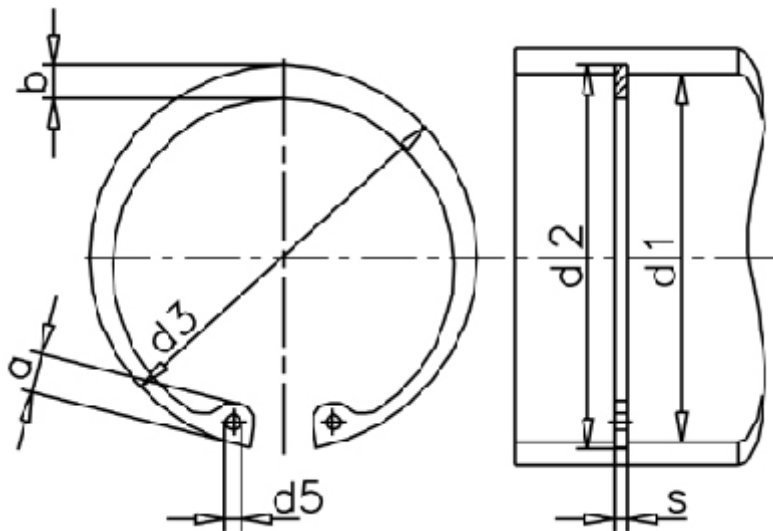

a max	=	FN kN	= 1033.00	t	= 5.00
AN mm ²	= 6200.0	FRg kN	= 91.0	tol	= +0,89
b	= 20.0	FR kN	= 764.0	tol	= +2,00-1,00
d1	= 390	g	= 5.0	tol	= -0.15
d2	= 400.0	K kN-mm	= 1751.0	Tong	= ZGJ-5
d3	= 407.00	m min	= 6.20	Weight kg/1000	= 960.00
d5 min	= 6.0	Nominal drive	= 15.0		
Description = J 390		s	= 6.00		